



Storage Electric Water Heater DOUBLE TANKS SERIES

USER MANUAL

D30-20ED6(D)
D50-20ED6(D)
D80-20ED6(D)
D100-20ED6(D)

Warning notices: Before using this product, please read this manual carefully and keep it for future reference. The design and specifications are subject to change without prior notice for product improvement. Consult with your dealer or manufacturer for details.
The diagram above is just for reference. Please take the appearance of the actual product as the standard.

THANK YOU LETTER

Thank you for choosing Midea! Before using your new Midea product, please read this manual thoroughly to ensure that you know how to operate the features and functions that your new appliance offers in a safe way.

EN

CONTENTS

| | |
|--|----|
| THANK YOU LETTER | 01 |
| SAFETY INSTRUCTIONS | 02 |
| SPECIFICATIONS | 04 |
| PRODUCT OVERVIEW | 05 |
| QUICK START GUIDE | 07 |
| PRODUCT INSTALLATION | 08 |
| OPERATION INSTRUCTIONS | 11 |
| CLEANING AND MAINTENANCE | 13 |
| TROUBLESHOOTING | 14 |
| TRADEMARKS, COPYRIGHTS AND LEGAL STATEMENT | 15 |
| DISPOSAL AND RECYCLING | 15 |
| DATA PROTECTION NOTICE | 16 |

SAFETY INSTRUCTIONS

Intended Use

The following safety guidelines are intended to prevent unforeseen risks or damage from unsafe or incorrect operation of the appliance. Please check the packaging and appliance on arrival to make sure everything is intact to ensure safe operation. If you find any damage, please contact the retailer or dealer. Please note modifications or alterations to the appliance are not allowed for your safety concern. Unintended use may cause hazards and loss of warranty claims.

EN

Explanation of Symbols



Warning

The signal word indicates a hazard with a medium level of risk which, if not avoided, may result in death or serious injury.



Attention

The signal word indicates important information (e.g. damage to property), but not danger.



Caution

The signal word indicates a hazard with a low degree of risk which, if not avoided, may result in minor or moderate injury.

Read these operating instructions carefully and attentively before using/commissioning the unit and keep them in the immediate vicinity of the installation site or unit for later use!

⚠ CAUTION: Risk of injury!

Before installing this water heater, check and confirm that the earthing on the supply socket is reliably grounded. Otherwise, the electrical water heater can not be installed and used. Do not use extension boards. Incorrect installation and use of this electrical water heater may result in serious injuries and loss of property.

Special Cautions

- The supply socket must be earthed reliably. The rated current of the socket shall not be lower than 10A. The socket and plug shall be kept dry to prevent electrical leakage.
- The installation height of the supply socket shall not be lower than 1.8m.
- The wall in which the electrical water heater is installed shall be able to bear the load more than two times of the heater filled fully with water without distortion and cracks. Otherwise, other strengthening measures shall be adopted.
- The pressure relief valve attached with the heater must be installed at the cold water inlet of this heater (see Fig.1), and make sure it is not exposed in the foggy. The water may be outflowed from pressure relief valve, so the outflow pipe must open wide in the air; The pressure relief valve need to be checked and cleaned regularly, so as to make sure it will not be blocked.

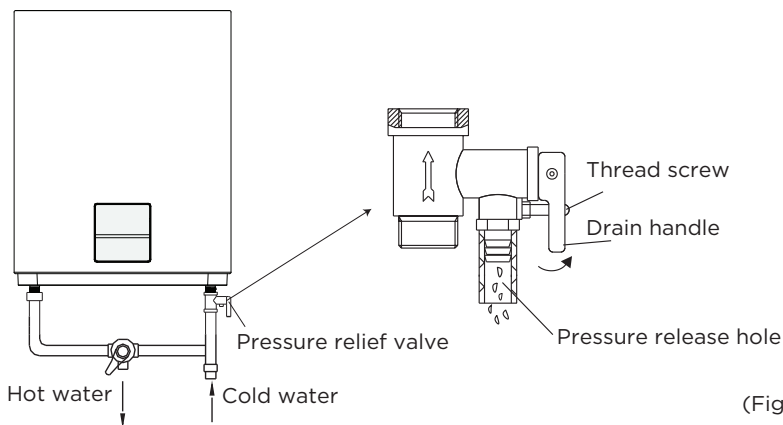

(Fig.1)

- When using the heater for the first time (or the first use after maintenance), the heater can not be switched on until it has been filled fully with water. When filling the water, at least one of the outlet valves at the outlet of the heater must be opened to exhaust the air. This valve can be closed after the heater has been filled fully with water.
- The water heater is not intended for use by persons (including children) with reduced physical, sensory or mental capabilities, or lack of experience and knowledge, unless they have been given supervision or instructions concerning use of the appliance by a person responsible for their safety. Children should be supervised to ensure that they do not play with the heater.
- During heating, there may be drops of water dripping from the pressure release hole of the multifunction valves. This is a normal phenomenon. If there is a large amount of water leak, please contact customer care center for repair. This pressure release hole shall, under no circumstances, be blocked; otherwise, the heater may be damaged, even resulting in accidents.

- The drainage pipe connected to the pressure release hole must be kept sloping downwards.
- Since the water temperature inside the heater can reach up to 75°C, the hot water must not be exposed to human bodies when it is initially used. Adjust the water temperature to a suitable temperature to avoid scalding.
- If the flexible power supply cord is damaged, the special supply cord provided by the manufacturer must be selected, and replaced by the professional maintenance personnel.
- If any parts and components of this electrical water heater are damaged please contact customer care center for repair.
- This appliance is not intended for use by persons (including children) with reduced physical, sensory or mental capabilities, or lack of experience and knowledge, unless they have been given supervision or instruction concerning use of the appliance by a person responsible for their safety.
- Children should be supervised to ensure that they do not play with the appliance.
- The maximum inlet water pressure is 0.5MPa; the minimum inlet water pressure is 0.1MPa, if this is necessary for the correct operation of the appliance.
- The water may drip from the discharge pipe of the pressure-relief device and that this pipe must be left open to the atmosphere; The pressure-relief device is to be operated regularly to remove lime deposits and to verify that it is not blocked.
- In order to drain away the water inside the inner container, it can be drained away from the pressure release valve. Twist the thread screw of the pressure release valve off, and lift the drain handle upwards.(See Fig.1) A discharge pipe connected to the pressure-relief device is to be installed in a continuously downward direction and in a frost-free environment.

SPECIFICATIONS

| Product Model | D30-20ED6(D) | D50-20ED6(D) | D80-20ED6(D) | D100-20ED6(D) |
|-----------------------------|--------------|--------------|--------------|---------------|
| Volume(L) | 27 | 47 | 74 | 93 |
| Rated Power(W) | 2000 | 2000 | 2000 | 2000 |
| Rated Voltage(ACV) | 220-240V~ | 220-240V~ | 220-240V~ | 220-240V~ |
| Rated Pressure(MPa) | 0.75 | 0.75 | 0.75 | 0.75 |
| Max Of WaterTemperature(°C) | 75 | 75 | 75 | 75 |
| Protection Class | I | I | I | I |
| Water Proof Class | IPX4 | IPX4 | IPX4 | IPX4 |

PRODUCT OVERVIEW

Product

EN

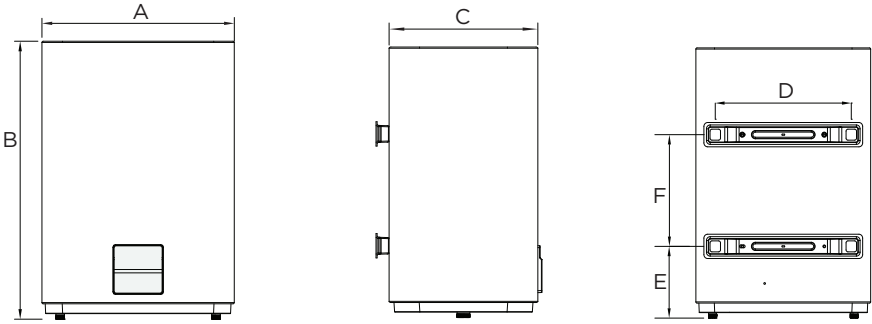

| | D30-20ED6(D) | D50-20ED6(D) | D80-20ED6(D) | D100-20ED6(D) |
|---|--------------|--------------|--------------|---------------|
| A | 469 | 469 | 569 | 569 |
| B | 589 | 875 | 902 | 1087 |
| C | 245 | 245 | 295 | 295 |
| D | 365 | 365 | 485 | 485 |
| E | 183 | 183 | 265 | 265 |
| F | 302 | 470 | 365 | 550 |

(Note:All dimensions are in mm)

Internal Wire Diagram

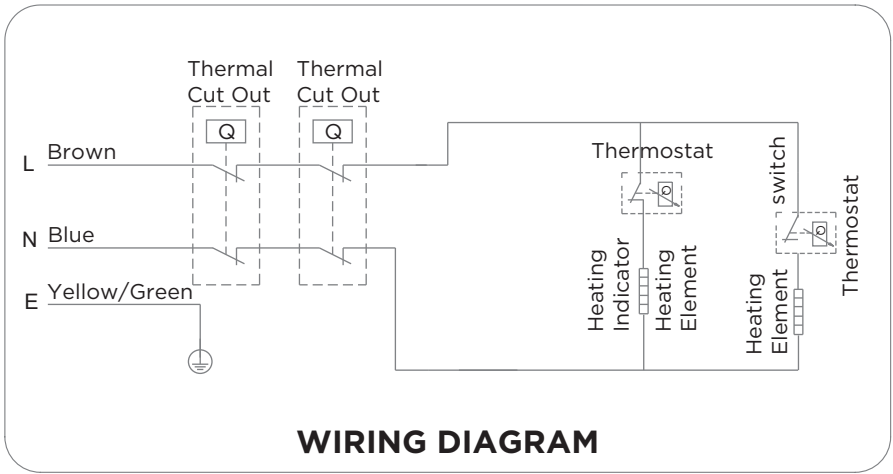

EN

Accessories

Safety valve × 1

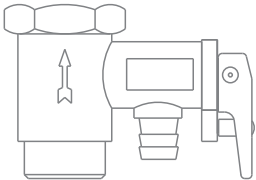

Wall hanging screw × 2

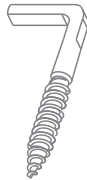

Plastic expansion pipe × 2

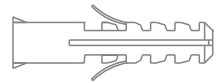

QUICK START GUIDE

Before First Use

CAUTION

Fill the inner tank with water before use.

EN

1. Plug in

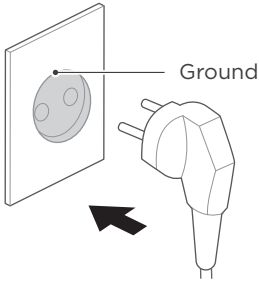

2. Startup of electric water heater.

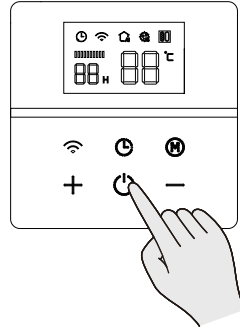

3. Setting of water inlet of electric water heater.

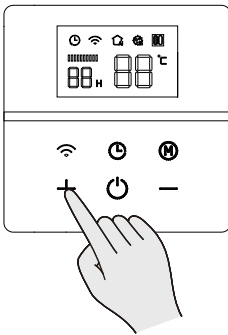

4. Open the water outlet valve, you can use hot water.

PRODUCT INSTALLATION

Installation Instruction

EN

1. This electrical water heater shall be installed on a solid wall. If the strength of the wall cannot bear the load equal to two times of the total weight of the heater filled fully with water, it is then necessary to install a special support.
In case of hollow bricks wall, ensure to fill it with cement concrete completely.
2. After selecting a proper location, determine the positions of the two install holes used for expansion bolts with hook. Make two holes in the wall with the corresponding depth by using a chopping bit with the size matching the expansion bolts attached with the machine, insert the screws, make the hook upwards, tighten the nuts to fix firmly, and then hang the electrical water heater on it (see Fig.2).

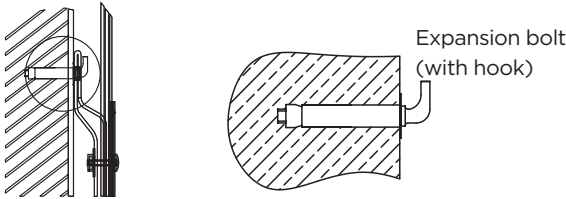

(Fig.2)

3. Install the supply socket in the wall. The requirements for the socket are as follows: 250V/10A, single phase, three electrodes. It is recommended to place the socket on the right above the heater. The height of the socket to the ground shall not be less than 1.8m (see Fig.3). If there is a fault on power cable, it should be replaced by the manufacturers, agencies or qualified person who is able to do this so as to ensure the safety.

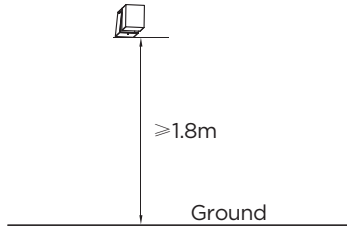
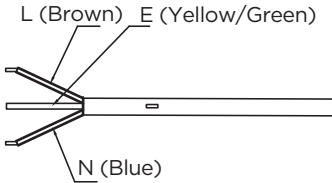

(Fig.3)

4. If the bathroom is too small, the heater can be installed at another place. However, in order to reduce the pipeline heat losses, the installation position of the heater shall be closed to the location shall be as near as possible to the heater.

Pipelines Connection

1. The dimension of each pipe part is G1/2" ; The massive pressure of inlet should use Pa as the unit; The minimum pressure of inlet should use Pa as the unit.
2. Connection of pressure relief valve with the heater on the inlet of the water heater.
3. In order to avoid leakage when connecting the pipelines, the rubber seal gaskets provided with the heater must be added at the end of the threads to ensure leak proof joints (see Fig.4).

EN

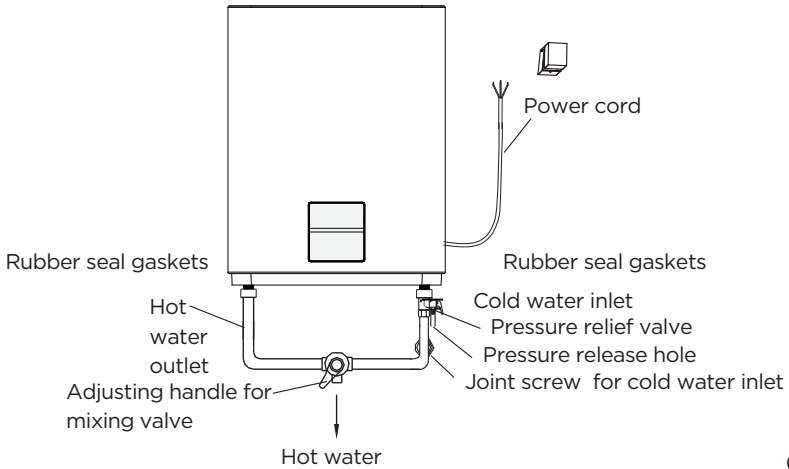

(Fig.4)

4. If the users want to realize a multi-way supply system, refer to the method shown in fig.5 and fig.6 for connection of the pipelines.

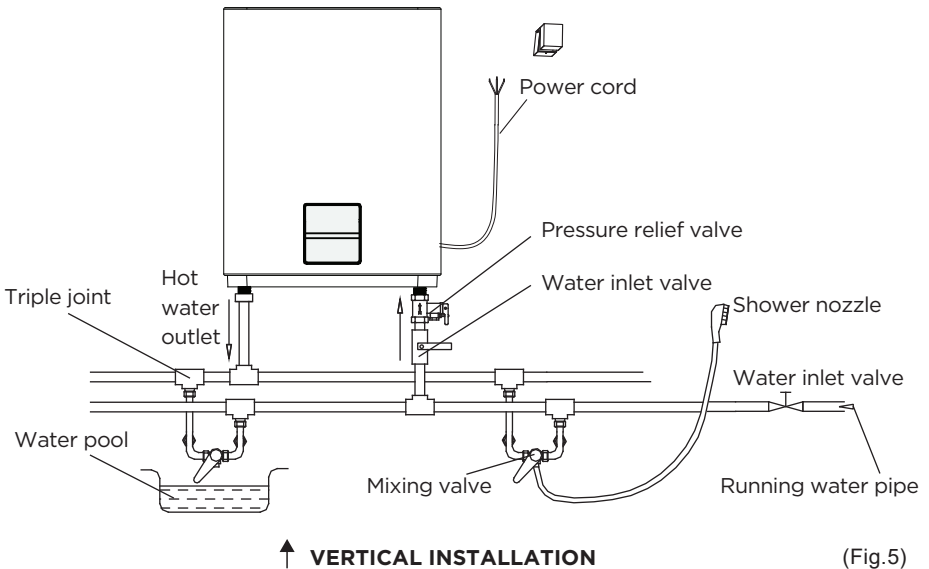

(Fig.5)

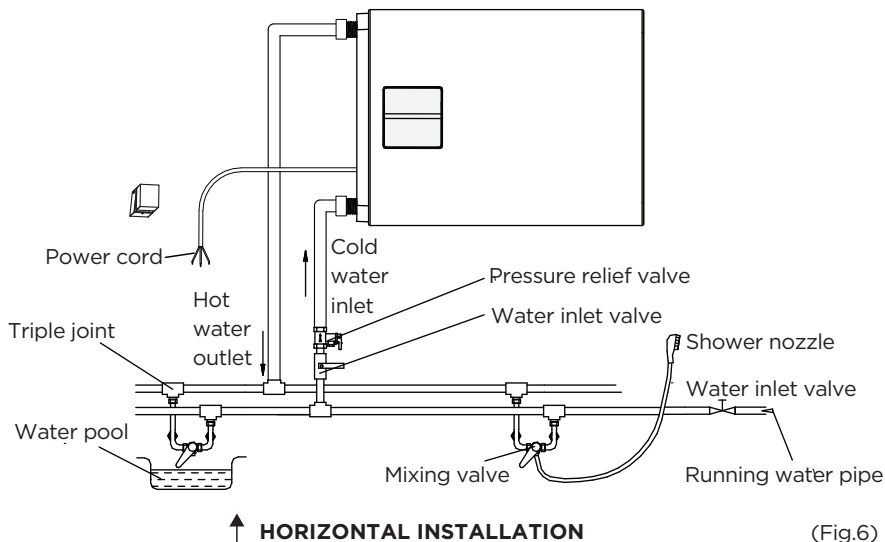

(Fig.6)

5. Horizontal installation, the direction of the water pipe must be on the left, if you want to change the direction of the control box, must be professional operation!

- 1) First of all, the power supply must be disconnected and the power cord plug must be removed;
- 2) Second, use a tool to pry open the reserved opening on the control box, and then install it after rotating the direction
- 3) Third, check whether the control box is installed around

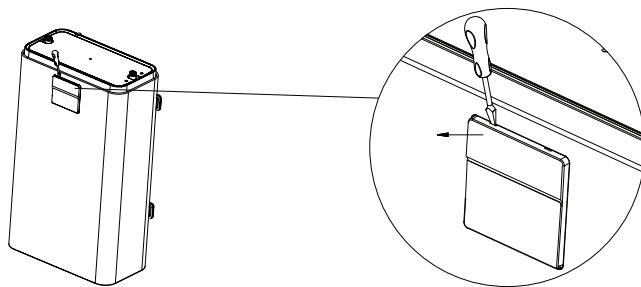

(Fig.7)

⚠ Only professional personnel are required for this operation

Note

Please be sure to use the accessories provided by our company to install this electric water heater. This electric water heater can not be hung on the support until it has been confirmed to be firm and reliable. Otherwise, the electric water heater may drop off from the wall, resulting in damage of the heater, even serious accidents of injury. When determining the locations of the bolt holes, it shall be ensured that there is a clearance not less than 0.3m on the right side of the electric heater, to convenient the maintenance of the heater, if necessary.

OPERATION INSTRUCTIONS

Methods of using

1. First, open any one of the outlet valves at the outlet of the water heater, then, open the inlet valve. The water heater gets filled with water. When water flows out of the outlet pipe it implies that the heater has been filled fully with water, and the outlet valve can be closed.

EN

Note

During normal operation, the inlet valve shall be always kept open.





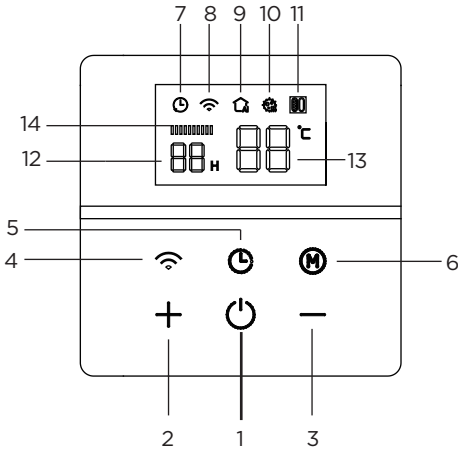

























2. Insert the supply plug into the supply socket, the two indicator lights will light up this time.
3. The thermostat will automatically control the temperature. When the water temperature inside the heater has reached the set temperature, it will switch off automatically, when the water temperature falls below the set point the heater will be turned on automatically to restore the heating.





Operating Of The Unit



(Fig.8)

| | | |
|------|--|---|
| No.1 | | ON/OFF Turn the unit on or off. |
| No.2 | | Temp.: *Increases temperature in 1°C increments. *Max. temp. is 75°C. |

| | | |
|------|---|--|
| No.3 | — | <p>*Decreases temperature in 1°C increments. *Min. temp. is 30°C. As the temp. is adjusted, light 12  changes accordingly. When the temperature adjustment is stopped, a flash occurs for 3 s. After that, the value returns to the current outlet water temp.</p> |
| No.4 |  | <p>Wireless Connection: Press  for 3 secs, icon  starts to flash. Then refer to "APP SETUP AND OPERATION".</p> |
| No.5 |  | <p>Appointment: Set hot water READY in a certain period. 1) One-time setting on the water heater: • Press button  and lights 12  starts to flash. Press the "+" or "-" button to adjust the ready time. "06H" means warm water READY in 6 hours, and the adjustment interval is from 2 -23 hours. If there is no adjustment within 5 seconds or press button , the light 12  stops flashing, and the time is set successfully. • After the time is set, the light 13  will start flashing. Press the "+" or "-" button to adjust setting temp. The adjustment range is 30-75°C. If do not adjust within 5 seconds or or press button , the light 13  will stop flashing. Setup succeeded; icon  is on. • Cancel the appointment. Press button  again; then icon  will be off. If icon  is still on, means there is other appointments in APP. Needs to cancel appointments in the APP, then icon  will be off. 2) Repeated appointments can be set on the APP. 3) Can still choose single/double-tank heating.</p> |
| No.6 |  | <p>Mode: Press  to cycle through functions: Memo U  Sterilization  single/double-tank mode  MEMO U Function : When the Memo U function is on, it analyzes your hot water consumption and keeps it at 75°C for the first week. It then starts to set your hot water schedule based on your regular routine from the next week. Press the button , icon 9  lights up, and the MEMO U function starts. If you press the button  again or manually adjust the set temp on the water heater, the MEMO U function will be automatically turned off. But in APP, it does not allow to adjust temp during Memo U function is on, unless to turn off this function. If power off, turn off, or cycle through to other functions, the MEMO U function is disabled and the related date writing is cleared. Need to press button  to learn again. MEMO U cannot be executed in the mode of repeated appointments.  Sterilization Function : Extra heat up to 80°C lasting 5 mins; and after that returns to previous setting temp. Press button  till icon  is on. When Sterilization function is on, it's unable to adjust the temp. Should turn off this function before adapting temp.  Cautions! Beware of scalding when the Sterilization Function is on.</p> |

| | | |
|------|---|---|
| No.7 |  | <p>Single- tank heating: Only 1 tank is heated up. Meet your temporary demand for less warm water consumption. Flex capacity to fit user counts. Precise energy savings. Press button  till icon  is on. If  is off, it means in Double- tank heating function. Double- tank heating: Both tanks are heated up with 2 heating elements.</p> |
| No.8 |  | The percentage of hot water that has been heated to the set temp. |

EN

Error code for serviceman's use

E2: Dry Ashing---Top up with water and re-heat.

E3: Overheating---Check the heating system or replace it.

E4: Sensor Fault---Check the sensor or replace it.

CLEANING AND MAINTENANCE

Methods of using

1. Temperature limiter cut off electricity if water heater is overheated or thermostat damages. Manual resetting is needed. Resetting knob is as follows (see Fig.9).

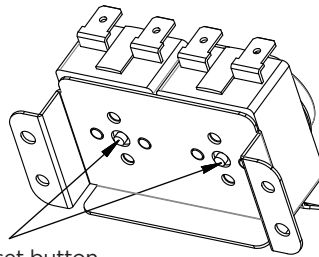

Manual reset button

(Fig.9)

Warning

Non-professionals are not allowed to disassemble the thermal switch to reset. Please contact professionals to maintain. Otherwise our company will not take responsibility if any quality accident happens because of this.

2. Check the power supply plug and socket frequently to make sure that they have good, reliable contact and are well grounded without overheating phenomenon.
3. If the heater is not used for a long time, especially in the regions with low atmospheric temperature (lower than 0°C), the water inside the heater shall be drained away. This will prevent the damage to the heater due to water freezing in the inner container, (Refer Cautions in this manual for the method to drain away the water from the inner container).
4. In order to ensure that the water heater operates efficiently for a long time, it is recommended to clean the inner container and the deposits on the electrical heating components periodically.
5. It is recommended to examine the magnesium anode protection materials every six months or so. If all the material has been consumed, please replace with the new material.

Warning

Do cut off power supply before maintenance, to avoid danger like electric shock.

TROUBLESHOOTING

| Failures | Reasons | Treatment |
|--|--|---|
| The heating indicator light is off. | Failures of the temperature controller. | Contact with the professional personnel for repair. |
| No water coming out of the hot water outlet. | 1. The running water supply is cut off. | 1. Wait for restoration of running water supply. |
| | 2. The hydraulic pressure is too low. | 2. Use the heater again when the hydraulic pressure is increased. |
| | 3. The inlet valve of running water is not open. | 3. Open the inlet valve of running water. |
| The water temperature is too high. | Failures of the temperature control system. | Contact with the professional personnel for repair. |
| Water leak. | Seal problem of the joint of each pipe. | Seal up the joints. |

Note

Parts illustrated in this use and care manual are indicative only, parts provided with the product may differ with illustrations. This product is intended for household use only. Specifications are subject to change without notice.

TRADEMARKS, COPYRIGHTS AND LEGAL STATEMENT

Midea logo, word marks, trade name, trade dress and all versions thereof are valuable assets of Midea Group and/or its affiliates (“Midea”), to which Midea owns trademarks, copyrights and other intellectual property rights, and all goodwill derived from using any part of an Midea trademark. Use of Midea trademark for commercial purposes without the prior written consent of Midea may constitute trademark infringement or unfair competition in violation of relevant laws.

EN

This manual is created by Midea and Midea reserves all copyrights thereof. No entity or individual may use, duplicate, modify, distribute in whole or in part this manual, or bundle or sell with other products without the prior written consent of Midea.

All the described functions and instructions were up to date at the time of printing this manual. However, the actual product may vary due to improved functions and designs.

DISPOSAL AND RECYCLING

Important instructions for environment

Compliance with the WEEE Directive and Disposing of the Waster Product:
This product complies with EU WEEE Directive (2012/19/EU). This product bears a classification symbol for waster electrical and electronic equipment (WEEE).

This symbol indicates that this product shall not be disposed with other household wastes at the end of its service life. Used device must be returned to official collection point for recycling of electrical electronic devices. To find these collection systems please contact to your local authorities or retailer where the product was purchased. Each household performs important role in recovering and recycling of old appliance. Appropriate disposal of used appliance helps prevent potential negative consequences for the environment and human health.

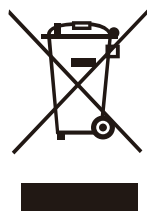

Compliance with RoHS Directive

The product you have purchased complies with EU RoHS Directive (2011/65/EU). It does not contain harmful and prohibited materials specified in the Directive.

Package information

Packaging materials of the product are manufactured from recyclable materials in accordance with our National Environment Regulations. Do not dispose of the packaging materials together with the domestic or other wastes. Take them to the packaging material collection points designated by the local authorities.

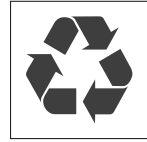

EN

DATA PROTECTION NOTICE

For the provision of the services agreed with the customer, we agree to comply without restriction with all stipulations of applicable data protection law, in line with agreed countries within which services to the customer will be delivered, as well as, where applicable, the EU General Data Protection Regulation (GDPR).

Generally, our data processing is to fulfil our obligation under contract with you and for product safety reasons, to safeguard your rights in connection with warranty and product registration questions. In some cases, but only if appropriate data protection is ensured, personal data might be transferred to recipients located outside of the European Economic Area.

Further information are provided on request. You can contact our Data Protection Officer via **MideaDPO@midea.com**. To exercise your rights such as right to object your personal data being processed for direct marketing purposes, please contact us via **MideaDPO@midea.com**. To find further information, please follow the QR Code.



make yourself at home



www.midea.com

Warranty terms

1. Warranty period:

The warranty period for the water heater and all its components (including all electronic parts, but excluding consumable parts such as: anode and safety valve) is 5 years from the date of purchase, subject to the exceptions noted below. This warranty applies to Midea water heaters purchased in the following countries: Estonia, Latvia, Lithuania. In Finland and Sweden there is a standard 2 year warranty.

After the expiration of the standard two-year warranty period provided by law, the product becomes subject to an extended warranty, valid for a further 3 years under the conditions specified by the Importer. During the 3-year period after the standard 2-year warranty, warranty obligations do not apply to the dismantling and installation of water heaters, transportation and other costs, but are limited solely to the repair of the product, replacement of the product with the same or similar in model and cost, or partial refund of the cost goods.

The extended 3-year warranty from the importer expires 5 years from the date of purchase. During the extended 3-year warranty, replacement or repair of the product will not extend the warranty period.

Additional information about the extended 3-year warranty from the Importer on the website: www.nordic-comfort.com

2. Installation and operation:

When installing a water heater, it is necessary to leave at least 0.3 m of free space between the water heater and another object so that the heating element of the water heater can be quickly and easily replaced. Otherwise, the cost of replacing the heating element may not be covered by the warranty if the technician has to perform additional steps to replace the heating element (removing the water heater, etc.).

3. Maintenance requirements:

To maintain the free warranty, the water heater must be descaled/cleaned once a year if the water hardness value exceeds 4 mEq/L. Failure to do so may void the warranty if calcium deposits are found in the tank or heating element when the boiler fails.

The importer is not responsible for damage caused by exposure to hard water and scale formation. It is recommended to use water softeners for all water supplies in the apartment/house to prevent scale formation.

4. Warranty Disclaimer:

The importer has the right to refuse warranty service if he discovers a violation of the warranty terms or if the damage is caused by improper installation or operation of the water heater, which contradicts these instructions.

5. Warranty claims procedure:

To claim under warranty, you must contact an authorized service center with a receipt confirming the purchase of the water heater, the product serial number and a brief description of the problem.

Attention! If you have a problem with your water heater, first contact your warranty service and use their recommendations. Before this, it is prohibited to remove the water heater from the wall and send it to a store or service center, in which case the free warranty may be void.

Attention! The warranty does not cover consumable parts such as anode and safety valve.

Warranty centers:

Lithuania: www.helpgroup.lt,

Latvia: www.helpgroup.lt, +371 6622 21 87

Estonia: POS Elektroonika OU, +372 6460093, remont@pos.ee

Finland, Sweden: Contact the store where the product was purchased.

Important information for the consumer!

To ensure reliable operation of the water heater in hard water conditions (water hardness value above 4 mEq/l), we recommend regularly descaling. This not only extends the life of the water heater, but also ensures that it operates energy-efficiently. Otherwise, the heating element will heat the scale deposits instead of the water, so you will get less hot water but waste more electricity.

Use Your Appliance with the SmartHome App

Before you start, make sure that:

- 1.Your smartphone is connected to home wifi network, and you know the network password.
- 2.Make sure you are next to home appliances.
- 3.The 2.4GHZ (preferable) or 5GHZ band wireless signal is enabled on your wireless router.

1 Download SmartHome App

Scan the QR code below, or search for "SmartHome" in Google play(Android devices) or App Store(ios devices) to download the app.



2 Register or Login account

Open the App and create a user account, if you already have one, just log in.



3 Add your appliance

Tap the "+"icon to add home appliance to your SmartHome account.



4 Connected to the network

Follow the instructions in the app to set up the WiFi connection. If the network connection fails, please refer to the App tips for operation.



WiFi Status Light

| | | |
|--|------------------------|-----------------------------------|
| | Slowly flashing | Waiting for connection |
| | Quickly Flashing | Connecting |
| | Quickly flashing solid | Connected to your wireless router |

Notes on networking

- When networking the product, please make sure that the mobile phone is as close as possible to the product.
- According to the App tips, if the product only supports 2.4GHZ wifi communication, please note that the 2.4GHZ network is selected for connection.
- Midea recommends WiFi router SSID names contain only alphanumeric values. If special characters, punctuation marks or spaces are used it might prevent the SSID name from showing up in the available networks to join in the App. Try it and if the SSID shows up then it is ok to use, otherwise log into the router and change the SSID name.
- A large number of devices on the WiFi router can affect network stability, there is no way that Midea can advise a specific number limitation as this depends on router quality and many other factors.
- If the router or WiFi name and WiFi password change, please repeat the above process to reconnect to the network.
- As the product technology is updated, the content of SmartHome may change, and the actual display in SmartHomeApp shall prevail.

Guidelines for Electric Water Heater Distribution Network

1、 When the water heater is powered on, the wifi signal will automatically activate and flash (“①”). If there is no network operation for 10 minutes, the wifi icon will automatically go out; After extinguishing, you can press this button for 3s to activate again;

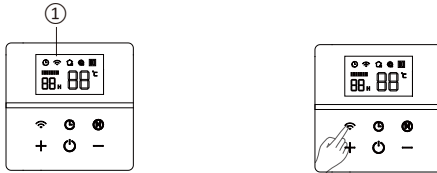

① When the water heater is powered on, the wifi signal will automatically activate and flash

② If there is no network operation for 10 minutes, the wifi icon will automatically go out; After extinguishing, you can press this button for 3s to activate again;

2、 Click “+” on the APP display interface to select “electric water heater” and select the corresponding product model, such as D30-20ED6, if the product model is D30-20ED6, then select D30-20ED6

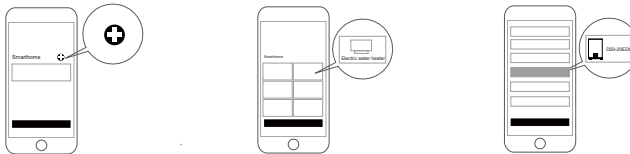

① Select product category

② Choose electric water heater

③ Choose the same model as the product

3、 Enter the home wifi account and password, Go to the next step, The system prompts “Smarthome” to join the wireless LAN “Midea_XXXX”, choose join.

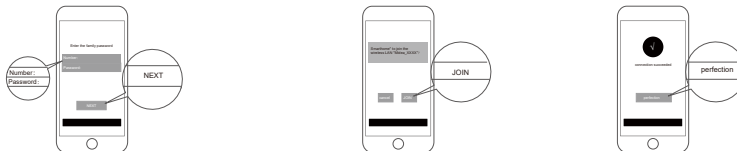

① Enter home wifi number and password

② Choose “JOIN”

③ Choose “perfection”

3.1 If you enter the wifi password and proceed to the next step, no network signal is received: Smarthome to join the wireless LAN “Midea_XXXX”, you need to press and hold the network key again for 3 seconds to light up the icon



- ① Start up the machine after powering it on.
- ② Hold the **【WIFI】** button for more than 3 seconds.

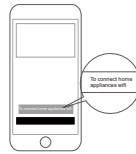

- ② The electric water heater has sent a wifi signal, please connect this mobile phone to this wifi:
wifi: MideaXXXX
wifi password: XXXXXX



- ③ Find the wifi signal with ""MideaXXXX"" and connect

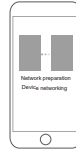

- ④ Go back to the APP interface and complete the network connection

4. For the first use, you need to complete the settings according to the instructions to confirm the product; please operate according to the prompts

The product WiFi is in conformity with IEEE 802.11a, 802.11b / g / n standard

Connecting Your Device to Amazon Alexa and/or Google Assistant

Your Midea device works with Alexa and/or Google Assistant.

Before you can use the voice control features with Midea appliance, please follow the steps below:

- 1** Make sure device connected with SmartHome App
Use the "SmartHome" app to setup the device for app control, you can follow the user guides of "Use Your Appliance with the SmartHome App" in product manual book.



- 2** Search for "SmartHome" Alexa skill/Google action
In the Amazon Alexa App Browse SKILL to search for "SmartHome" skill.
In the Google Home App, click "+" to set up device (Works with Google), and then search for "SmartHome" action.



- 3** Enable "SmartHome"
Enable "SmartHome" Alexa skill/Google action, and then login your SmartHome App account in the H5 and agree the linking.



- 4** Try voice control with your devices
After setup is complete, try asking Alexa/Hey Google to control your Midea home appliance.



Things to Try

Available voice commands of your Midea device

Alexa

1. Turn on/off the water heater/(Device name)
2. Set the water heater/(Device name) to xxx degrees (temperature range xx-xx)

.....

Google Assistant

1. Turn on/off the water heater/(Device name)
2. Set the water heater/(Device name) to xxx degrees (temperature range xx-xx)

.....